

# LT Q2

## Pyroelectric Single Element Detector for Measurement Applications

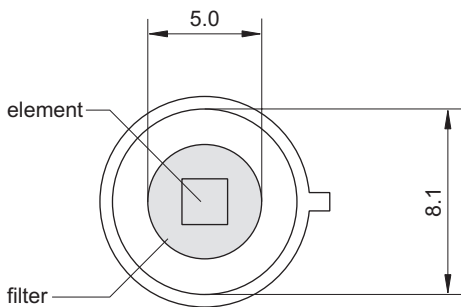
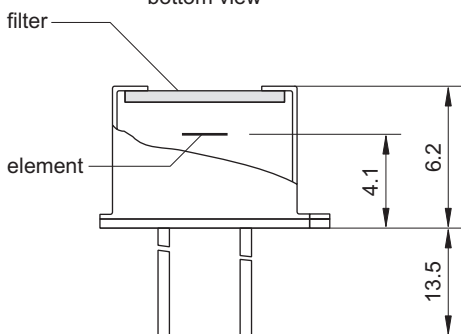
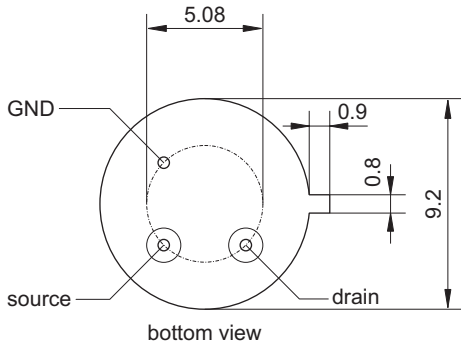

element size	2 mm × 2 mm
aperture	5.0 mm
filter <sup>3</sup>	custom-designed
responsivity <sup>1,2</sup>	>300 V/W
noise <sup>1</sup>	<150 nV/√Hz
specific detectivity <sup>1,2</sup>	>4·10 <sup>8</sup> cm √Hz/W
offset voltage	0.4 to 1.5 V
operating voltage	2 V to 18 V
housing	TO 39
operating temperature	-20 to 70 °C
storage temperature	-20 to 70 °C

- 1) frequency: 10 Hz, detector temperature: 25 °C
- 2) black body source temperature: 500 K, filter transmission: 100 %
- 3) other filters on request

